

# User Manual

Eck/Corner-Fireplace

©2023

**BRUNNER**<sup>®</sup>  
*made in germany.*

## CONTENTS

<b>1</b>	<b>Note to the ceramic glass pane.....</b>	<b>4</b>
<b>2</b>	<b>Safety precautions.....</b>	<b>5</b>
<b>3</b>	<b>Firewood and heating power.....</b>	<b>8</b>
<b>4</b>	<b>Adjusting of combustion air.....</b>	<b>12</b>
<b>5</b>	<b>Designation of components.....</b>	<b>13</b>
<b>6</b>	<b>Basic rules for operation.....</b>	<b>14</b>
<b>7</b>	<b>Lighting fire in a cold fireplace.....</b>	<b>18</b>
<b>8</b>	<b>Stoking up in a warm fireplace.....</b>	<b>19</b>
<b>9</b>	<b>Cleaning.....</b>	<b>20</b>
<b>10</b>	<b>Disposal.....</b>	<b>22</b>
<b>11</b>	<b>Troubleshooting.....</b>	<b>24</b>
<b>12</b>	<b>Note.....</b>	<b>26</b>

Please read the entire User Guide before lighting the fire for the first time. In particular, please note the safety precautions in this manual.

The intended use is provided if the operation specified in these instructions is observed.

The non-observance of installation and operating instructions will void the warranty. Any constructional modifications made by the system operator are not allowed!

Installation must be carried out by an authorized stove-fitter, because safety and efficiency of the system depend mostly on proper installation of the product. All valid stove fitting rules and regulations of building law must be observed and followed.

This fireplace is subject to the provisions of BImSchV (Federal Emission Protection regulation).

Necessary national and European standards and local regulations must be observed.

Please follow the relevant regulations of your country. In case of doubt, check the valid conditions for the operation of fireplaces in your local area.

Subject to technical changes!

Please keep the User Guide for future reference!

For an extended product warranty and a good processing of spare parts deliveries, we recommend carrying out the BRUNNER product registration on ([www.produktregistrierung.brunner.de](http://www.produktregistrierung.brunner.de)).

# 1 NOTE TO THE CERAMIC GLASS PANE

BRUNNER uses only high quality glass ceramic.

In a special manufacturing process, the glass panes become cerammed and acquire their unique features.

During this process, it is technically not possible to exclude all optical impairments (fine scratches, solid in-clusions, tiny air bubbles\*) .These must be accepted as results of current technology status, and cannot be considered as reasons for complaint.

- \*) - max. 3 air inclusions or solid inclusions < 4mm are accepted, however, no air inclusions protruding to the glass surface with opening larger than 1mm.  
- décor defects smaller than 1mm are allowed as manufacturing tolerances.

## 2 SAFETY PRECAUTIONS



### **Initial operation**

The paint coat of the stove is not completely hardened before reaching normal operating temperature for the first time. Smoke emissions and unpleasant odours cannot be excluded. Therefore, provide sufficient ventilation of the room when lighting the fire. Open all doors and windows, use an electric fan if necessary, to ensure faster air exchange within the room. During first operation try to avoid staying in this room for too long, if possible.



### **Fireplace door**

The fireplace door should be opened only for loading firewood or cleaning. When the fireplace door is opened, other fireplaces connected to the same chimney might be affected. Under certain circumstances this can lead to risk of flue gas poisoning. The fireplace door must stay closed even if the fire is not burning.

**Risk of burns**

External surfaces of the fireplace, in particular the glass door, may get very hot. Do not touch - risk of burns! Remember to warn your children about this. Basically, children should stay away from a burning stove. Objects made of flammable materials may not be placed on available surfaces of the fireplace. Flammable textile fabrics must have a minimum distance of **5 cm** from the vertical surfaces of the fireplace.

Remember to remove only cold ashes from the fireplace. For your own security, store the ashes in a fire-resistant container for at least 24 hours before you dispose of them - Fire hazard! In case of fire call the fire brigade immediately! In the case of chimney fire move all flammable parts and elements away from the chimney. Watch out for flying sparks. Never use substances as petrol or alcohol to light a fire!

**Air gratings**

Do not close or cover up the warm air vents of your fireplace. Risk of fire or overheating!

**Fireplaces with electronic control systems**

After closing the fireplace door a message must be displayed, informing that the combustion has been started (see User Guide of the control system)! If this is not the case, the door contact switches are defective! **Risk of deflagration!** Consult your stove fitter and follow the instructions in chapter “Manual adjusting of combustion air in the case of emergency” of the User Guide for the control system.



## **Heat radiation range**

Flammable objects of any kind must be kept outside the heat radiation range of 80 cm in front of the glass door! Fire hazard! Do not leave any flammable objects in front of the fireplace door. Inside the heat radiation range no objects with flammable parts are allowed.

### 3 FIREWOOD AND HEATING POWER

The combustion process in our devices has been optimized to enhance their performance and reduce emissions. You can support our efforts to protect our environment by respecting the following recommendations for low-emission heating: Use only dry, natural wood with a residual humidity factor below 20%, or wood briquettes according to DIN EN 17225-3.

Damp, freshly cut or improperly stored wood has a high water content, therefore does not want to burn, makes a lot of smoke and gives not much of heat. Use only firewood which has been stored for at least two years in a dry place with sufficient air circulation. Because dry wood is much more calorific, you can save on fuel costs.

For example: Dry wood has a calorific value of approx. 4 kWh/kg, freshly cut wood only 2 kWh/kg. You will need twice the amount of wood to achieve the same heating power.

	<b>Water content g/kg wood</b>	<b>Calorific value kWh/kg</b>	<b>Consumption raised by %</b>
very dry	100	4,5	0
stored for 2 years	200	4	15
stored for 1 year	350	3	71
freshly cut wood	500	2,1	153



Natural firewood (left) is the best fuel for fireplaces, but you can use also wood briquettes according to DIN 17225-3, Class A1, length >14 cm (5.51 in), diameter >8 cm (3.15 in) (right).





What amount of heat will I get when buying wood per weight?

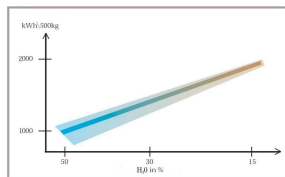

1 cubic meter freshly cut wood	Water content 50%	500 kg x 2,0 kWh/kg = 1000 kWh
1 cubic meter dried wood	Water content 30%	500 kg x 3,3 kWh/kg = 1650 kWh
1 cubic meter dry wood	Water content 15%	500 kg x 4,1 kWh/kg = 2050 kWh

What amount of heat will I get when buying wood per volume (1 cubic meter = 1 m<sup>3</sup>)?

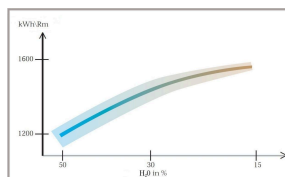

1 cubic meter freshly cut wood	Water content 50%	1286 kWh
1 cubic meter dried wood	Water content 30%	1518 kWh
1 cubic meter dry wood	Water content 15%	1550 kWh

Most suitable for use in open fireplaces are all types of hardwood, like beech or birch. Softwood species (conifers) have a closed-cell structure which is bursting during combustion, causing glowing embers to be thrown out of the fireplace. Hardwood is burning more calm and evenly.

You can control the heat radiation intensity by volume of wood and the intervals for stoking up.

Adjusting the heat by reducing the volume of combustion air is wrong! If there is not enough combustion air available, the energy contained in firewood cannot be completely released. At the same time, the emissions are rising due to unburned particles.

Too much of firewood or inappropriate fuel types can cause overheating and damage.

No kind of waste shall be burned in a fireplace!

### ***Waste on fire = Toxins in your garden!***



Never use combustible fluids, like petrol or alcohol to light a fire!

Mind the waste incineration ban!

Remember to use only the recommended fuels described in this User Guide. Unsuitable, not recommended fuels are not allowed to be burned in a fireplace.

### **Firewood volumes - Eck-Kamin fireplaces**

<b>Fireplace</b>	<b>Load volume min. max.</b>	<b>Log length</b>
Eck-Kamin 42/42/42	2 kg - 3 kg	33 cm
Eck-Kamin 42/57/30	2 kg - 3 kg	25 cm - 33 cm
Eck-Kamin 51/52/52	2 kg - 3 kg	25 cm - 33 cm
Eck-Kamin 57/52/52	2 kg - 3 kg	25 cm - 33 cm
Eck-Kamin 57/82/48	2 kg - 3,5 kg	25 cm - 33 cm
Eck-Kamin 57/67/44	2 kg - 3,5 kg	25 cm - 33 cm
Eck-Kamin 70/33/33	2 kg - 3 kg	25 cm
Architektur-Eck 53/121/50	3 kg - 4 kg	25 cm - 100 cm
Architektur-Eck 38/86/36	2,5 kg - 3,5 kg	25 cm - 33 cm
Architektur-Eck 45/101/40	3 kg - 4,5 kg	25 cm - 50 cm

Fireplace	Load volume min. max.	Log length
Architektur-Eck 45/67/44	2 kg - 3,5 kg	25 cm - 33 cm
Architektur-Eck 45/82/48	2 kg - 3,5 kg	25 cm - 33 cm



Loading too much wood into an Eck-Kamin fireplace or using improper fuel may cause overheating and risk of fire!

## 4 ADJUSTING OF COMBUSTION AIR

Combustion air is supplied directly into the fireplace through a separate air connection. In manually operated fireplaces, combustion air is adjusted with the control element provided on the unit. For units with electronic stove control system, please refer to the instructions supplied with the control system.

Lighting up / max. heating power:  
Lighting fire in a cold fireplace and maximum burning power.

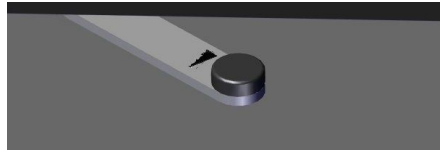

Rated power: Central position of the control element.

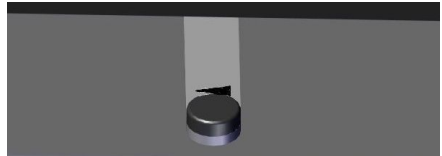

Glow: Combustion air supply is shut off.

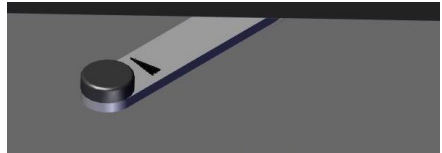

**CAUTION:** Risk of deflagration! Set the 'Glow' position only after the fire has burned down completely.

Respect the ventilation requirements for simultaneous operation with other fireplaces. Pay particular attention to the requirements for operation together with ventilation systems.

## 5 DESIGNATION OF COMPONENTS

Devices shown below are presenting only one of several possible designs of the glass door. Models with different glass shapes/dimensions are described separately, if any differences regarding operation exist.

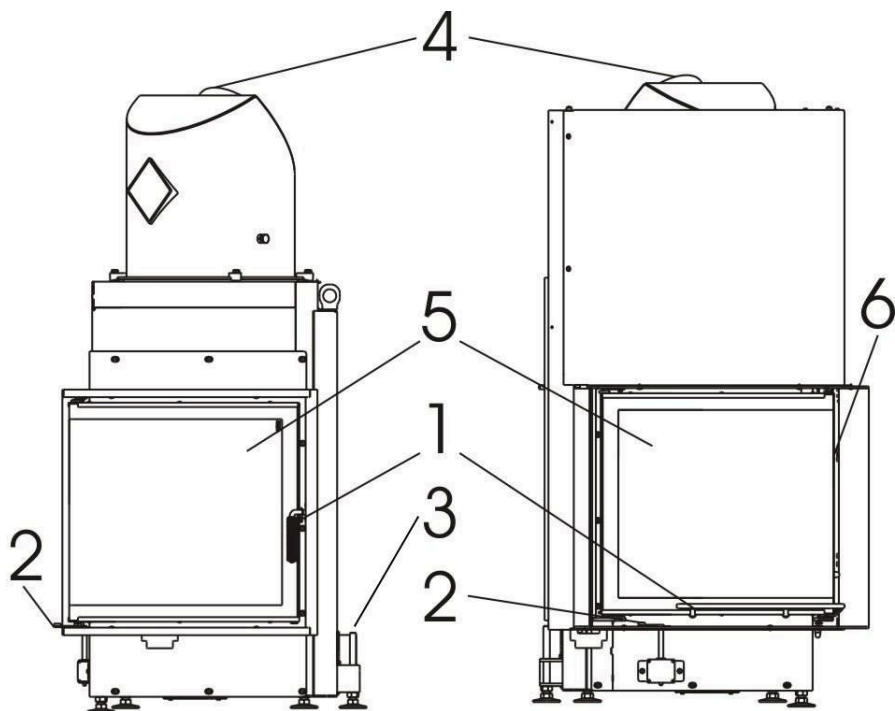

*Im. 1: Eck-Kamin with side-opening / lifting door (shown with steel hood, as an example)*

1	Fireplace door	2	Combustion air control element (separately)
3	Air supply connection (lateral possible too)	4	Flue gas connection
5	Viewing glass	6	Klick-klack closing mechanism

## **6 BASIC RULES FOR OPERATION**

The service life and functionality of the heating insert depend on correct assembly, proper operation and regular care and maintenance.

The fireplace doors should be opened only for loading firewood or cleaning. BRUNNER heaters are designed and optimized for closed operation. When the fireplace door is open, other fireplaces connected to the same chimney might be impaired. Under certain circumstances this could lead to a risk of flue gas poisoning. The fireplace door must always stay closed, even if the fire is not burning.

Stoves and fireplaces from Ulrich Brunner GmbH are designed for periodic burning. It means that always a minimal amount of firewood has to be loaded and the combustion air must be adjusted according to the following instructions. Insufficient volumes of combustion air will lead to higher emissions and increased staining of the glass door.

Avoid risk of overheating! If the fireplace temperature is often too high, this can cause discolorations, especially in the case of stainless steel frames. Such defects do not constitute a reason for a claim.

### **Stoking wood**

For stoking up we recommend to use a protective glove or the “cold hand” (delivered with some models), because the door handle gets very hot after several hours of burning. Open the door slowly. This will avoid turbulences, which could draw the smoke into the room. The right time for stoking up is when the wood turned almost completely into glowing embers.

### **Heating with accumulation stoves**

When using your accumulation stove with ceramic storage mass, please keep the following heating intervals.

First put the maximal load of wood inside the stove, then light up from above and let it burn. After combustion ends, wait for approx. one hour, then put half the load of wood. After another hour has passed from combustion end, put half the load of wood again, if required. These steps can be repeated after a heating pause of eight hours. If more wood is loaded over a short time, this can result in overheating and storage mass damage.



Please ask your stove setter for the allowed loads and heating intervals. Different heating intervals will apply, when the stove is operated for the first time!

### Heating between seasons

The fireplace needs a chimney draught for combustion air suction and flue gas exhaust. This chimney draught is reduced, when outdoor temperatures begin to rise. When outdoor temperature exceeds 10°C (50°F), please check the chimney draught before lighting fire.

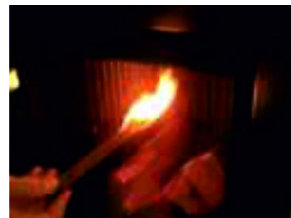

*Im. 2:  
Chimney draught test*

### Damper flap adjustment

If an optional damper flap\* has been installed, it has to be opened completely when the fire is lit. For normal operation with closed door, the damper flap can be closed up to 2/3, depending on chimney draught.

### Combustion air supply

Proper functioning of a fireplace depends on the volume of combustion air streaming into the room. Sufficient air supply must be ensured before fire is lit. If an outside air flap is installed, it has to be opened and must be left open as long fire is burning. Installed combustion air supply devices cannot be modified.

\* The damper flap is installed in the flue pipe connecting piece between the heating insert and the chimney and regulates the chimney draft.

## **Structural changes to the building**

If changes are planned and made in or on the building, the conditions for safe and proper operation of the fireplace can be significantly disrupted. The prerequisites for safe operation of the fireplace must therefore be checked by a specialist in the event of changes.

Such changes can be:

- Installation of an additional fireplace
- structural changes to the chimney
- Installation or modification of ventilation devices, e.g. extractor hood, toilet or bathroom ventilator, controlled ventilation
- Installation or modification of corresponding household appliances, e.g. exhaust air tumble dryer, central vacuum cleaner system
- Changes to the building's tightness, e.g. due to the installation of new windows or doors, insulation of roof surfaces, full thermal insulation

## **Combustion chamber linings**

**Important note:** Single cracks on fire-resistant combustion chamber linings are no reason for concern.

These exactly dimensioned fireclay plates are manufactured specially for our fireplaces. The pre-fired fireclay plates protect the steel body, have insulating properties and are an essential component of the low-emission “green” combustion chamber design. Most different temperature strains, as well as mechanical impacts can (or actually will) cause small cracks on these plates. This material condition is harmless and does not constitute a reason for a claim.

What is not normal, are chips of stone falling off, or noticeable, star-shaped cracks on several levels.

Black / anthracite surface of combustion chamber linings may show color changes during use. This is a normal, unavoidable process and does not constitute a reason for reclamation.



If the following points are taken into account, the black colour of the surface will remain intact for a long time:

- Operation as intended with the recommended filling quantities (surface temperature of fireclay < 700°C).
- No treated or coated wood, coal or liquid fuels; only natural wood with residual moisture <20%.
- Do not clean the surfaces with steel/wire brushes or cleaning agents.

## **Door sealing ropes**

BRUNNER is using only high-quality door sealing ropes, which are exactly adapted to the requirements of our heating devices.

Yet the door sealings are wear parts, and therefore are not covered by our product warranty.

If the stove is operated as intended, the normal lifetime will be significantly longer.

Overheating, due to loading more wood as described in the operating instructions, direct contact with burning particles (glue), as well as use of unsuitable and aggressive cleansing agents may reduce the product lifetime considerably.

## **Viewing glass**

When loading wood into the fireplace, make sure to avoid the falling of wood onto the viewing glass, where it could burn in contact with the glass. The resulting thermal stress could lead to permanent discolorations (grey stains) on the viewing glass.

## **7 LIGHTING FIRE IN A COLD FIREPLACE**

- 1 Make sure that the level of ashes is not too high. Maximum level: 3 -5 cm below door frame. If the level of ashes is too high, glowing embers can fall out of the fireplace when stoking up wood.
- 2 Set the control element into position for lighting up. Combustion air can now stream intensively on the firewood for faster flaming up.
- 3 Load some chopped firewood loosely into the fireplace. Put a good fire-starter, such as Fidibus between the logs and light the fire. Fire-starters are practical fire starting aids, which should be placed under or in front of the wood. Please note: big logs are not easy to light and heavy to burn in a cold fireplace. Never use petrol or alcohol as aids for lighting fire!
- 4 Close the fireplace door and watch the burning flames for some minutes. If the fire goes out, open the door slowly, put a new fire-starter between the logs and light up again.
- 5 When the fire was lit successfully, the combustion air control element can be set to rated power position.
- 6 If you do not wish to stoke up more wood, move the control element into Glow position as soon as no flames are visible, to avoid temperature loss through unnecessary streaming of air into the fireplace. You cannot choose this control element position during combustion and degassing of wood, because this will cut off air completely and the fire goes out. In case of rapid air streaming from the room (when fireplace door is opened) it is possible that the gases "trapped" inside the combustion chamber and downstream radiators/accumulators will suddenly react with oxygen and explode (deflagration).

## 8 STOKING UP IN A WARM FIREPLACE

- 1 Move the combustion air control element into position for lighting up and put a desired amount of logs on the glowing embers. After wood is laid on the embers it gets warm, moisture is driven out and evaporates. This will reduce temperature of the combustion chamber. At the same time, the volatile particles driven out of wood will need a lot of air to pass through this critical phase and flame up fast to reach high temperature required for clean combustion.
- 2 When the fire is burning bright, the combustion air control element can be set to rated power position.
- 3 If you do not wish to stoke up more wood, move the control element into Glow position as soon as no flames are visible, to avoid temperature loss through unnecessary streaming of air into the fireplace. You cannot choose this control element position during combustion and degassing of wood, because this will cut off air completely and the fire goes out. In case of rapid air streaming from the room (when fireplace door is opened) it is possible that the gases “trapped” inside the combustion chamber and downstream radiators/accumulators will suddenly react with oxygen and explode (deflagration).

**Another hint:** Use always smaller pieces of wood for lighting up. These will flame up faster and cause temperature in the combustion chamber to increase. The bigger and thicker logs are better for stoking fire. Some sorts of wood briquettes can swell during combustion, i.e. they expand under heat and their volume increases. That kind of fuel must be placed always close to the back wall of combustion chamber, to prevent contact with glass door.

## 9 CLEANING

Once in a year, when the heating season begins, make sure to inspect the smoke pipe and/or additional reheating systems for ashes and residues. This should be possible through a revision provided on the installed fireplace insert or the ceramic accumulator block (if mounted). Remove the ashes with a suitable vacuum cleaner.

When the fireplace was not used for a long time, call the chimney sweep to inspect and clean your chimney.

All cleaning operations must be carried out while the fireplace is cold –  
Risk of burns!

If the ceramic glass pane is only slightly stained, it can be cleaned with a dry cloth. Cleaning glass from dirty residues can be done easy with a piece of wet paper towel. Use it to pick some cold ashes from the combustion chamber of the fireplace. Clean the glass with this wet towel, then wipe the remaining wet ashes from the glass with a dry paper towel.



**Never use abrasive or aggressive cleaners!**



**Do not use brushes or any other mechanical means to clean sealing ropes!**

**During cleaning of glass, please protect the sealing ropes against getting wet.**

**Lifetime of sealing ropes will be significantly shorter, if they are soaked by fluids or cleaning agents.**

**Curing of the sealing rope can lead to glass breakage! Replace it when necessary!**

The fireplace needs always a thin bed of ashes to keep the glowing embers for longer. Do not clean the ashes completely, but always remove the “spare” cold ashes using a suitable vacuum cleaner (can be bought at your local stove dealer).



**Don't let the ashes rise above the top edge of fireclay bottom linings. The sealing ropes could get in contact with glowing embers and eventually get damaged.**

**Damage of sealing ropes arising from inappropriate operation or cleaning are excluded from warranty.**

Please follow the safety precautions regarding the handling of ashes and embers.

For the variants with a lifting window, proceed as follows to open or close the fireplace door for glass cleaning.



The fireplace door can be opened only using the handle!  
Caution: Never shut the door with force. Risk of glass breakage!

Please watch a videofilm under:

<https://www.youtube.com/watch?v=XuKSljPGyc>



Opening the door of the corner fireplace:

To clean the window, unlock the safety mechanism by pressing slightly with a finger.



*Im. 3: Opening the door left side for cleaning*



*Im. 4: Opening the door right side for cleaning*

Closing and locking the corner door:

1. Move the fireplace door close to the safety lock using the handle, catch with both hands the door handle.
2. Press gently in the direction shown by arrow and pull up slightly. The click klack closing mechanism clicks into place.



*Im. 5: Closing the door left side*



*Im. 6: Closing the door right side*

## 10 DISPOSAL

Old equipment contains valuable materials that must be recycled. Observe the applicable national legal regulations for disposal.



Danger of electrocution.

Electrical connections of the furnace system are under mains voltage. This can lead to electric shock.

Switch off the power supply

Secure power supply against restart.

Old metal parts can be disposed of as metal recycling.

Electrical and electronic components must be disposed of as electronic waste. Fireclay linings can be disposed of as rubble.

Fireclay linings can be disposed of as rubble.

Dispose of insulating and insulating materials of the heating or fireplace insert in a closed container on a suitable waste disposal site.

Do not put the glass ceramic discs in the waste glass collection container! The glass panes can be disposed of as normal household waste.

## 11 TROUBLESHOOTING

Problem	Cause	Solution
Smoke is coming out into the room	The combustion air adjuster is set to 'Keeping embers'.	Set the combustion air adjuster in 'fire starting' position.
	Unfavorable weather conditions; insufficient chimney draft.	Call your chimney sweep.
	A room ventilator (e.g. extractor hood) or mechanical ventilation system is causing negative pressure in the room, which is stronger than the chimney draft.	Turn off the room ventilator or mechanical ventilation system.  Install a negative pressure monitoring device (e.g. Brunner USA).
	Combustion air supply is blocked.	Call your fireplace contractor.
	The smoke pipe connecting piece between fireplace insert and chimney is blocked.	Please clean the smoke pipe connecting piece (this is usually not a chimney sweep's job).
	The chimney is blocked.	Call your chimney sweep.
	Unsuitable fuel	Wood is damp or too big pieces of firewood are used.  Please use the recommended fuel as indicated in these instructions.
Unusual smell	Deposits of dust	Heat up the stove strongly.  Provide for ventilation.



---

<b>Problem</b>	<b>Cause</b>	<b>Solution</b>
Glass panes are often dirty	Unsuitable fuel	Wood is damp or too big pieces of firewood are used.  Please use the recommended fuel as indicated in these instructions.
	Insufficient combustion air supply	Put the combustion air adjuster into 'fire starting' or rated power position.  Check the combustion air supply and smoke outlet. Call your fireplace contractor, if possible.
	Insufficient chimney draft	Call your chimney sweep.
Condensate build-up	Too damp wood is being used.	Please use the recommended fuel as indicated in these instructions.
	Insufficient combustion air supply	Put the combustion air adjuster into 'fire starting' or rated power position.  Check the combustion air supply and smoke outlet. Call your fireplace contractor, if possible.

## 12 NOTE

In case of damage to the fireplace or other parts of the system, please contact your stove fitter immediately. In case of severe damage of door sealing ropes - do not use the fireplace.

To ensure safe operation of the system, remember to use only genuine replacement parts.

Modifications on devices can be made only by persons with manufacturer's authorization.

The warranty expires if the device has not been used as intended. Intended use includes reading and following the instructions of this User Guide.

It is necessary to follow any other relevant instructions, like the "Operating instructions for tiled stove water boilers"!

***My stove fitting company:***

Ulrich Brunner GmbH  
Zellhuber Ring 17-18  
D-84307 Eggenfelden  
Tel.: +49 (0) 8721/771-0 / Fax: +49 (0) 8721/771-100  
Email: info@brunner.de

Technical and assortment changes as well as errors and misprints reserved.  
Reprinting and reproduction, even in part, only with the express permission of the publisher.

**Art. No.: 19903**